

# ASSEMBLING INSTRUCTION

1 X1PC



2 X1PC



3 X1PC



4 X1PC



A X4PCS



B X8PCS



C X4PCS



D X1PC



1

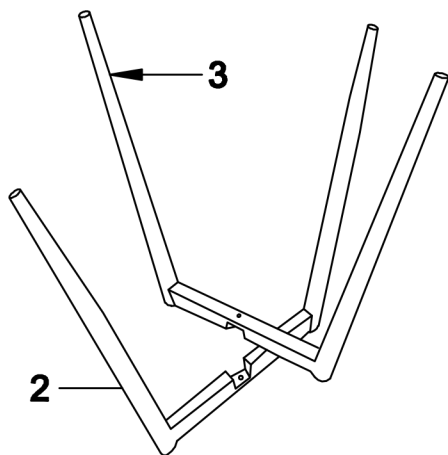

2

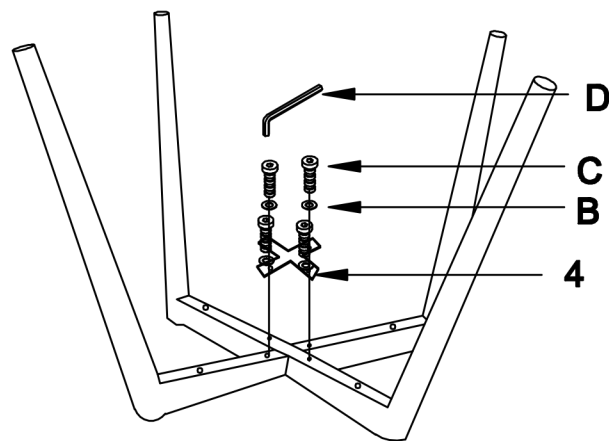

3

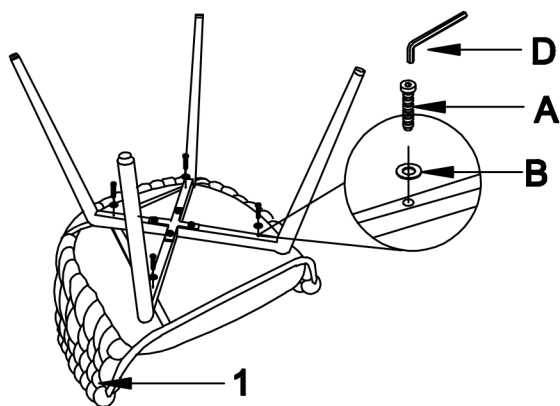
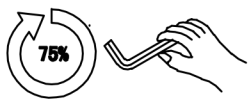

4

